

DLP PROJECTOR

USER'S GUIDE

Thank you for purchasing the DLP Projector.

Please read this user's guide to ensure correct use of the device. Save this user's guide for future reference.

OUTLINE

This DLP Projector can display various computer signals and NTSC/PAL/SECAM video signals.

FEATURES

- 1. High Brightness**
- 2. High Resolution**
- 3. Compact Size, Feather Weight for Portability**
- 4. Durable Magnesium Alloy Body**
- 5. RGB input Terminal**
- 6. One Touch Auto-Adjustment Function**
- 7. Easy Keystone Adjustment**

Copyright

Copyright © 2003. All rights reserved. No part of this publication may be reproduced, transmitted, transcribed, stored in a retrieval system or translated into any language or computer language, in any form or by any means, electronic, mechanical, magnetic, optical, chemical, manual or otherwise, without the prior written permission of the company.

Disclaimer

The company makes no representations or warranties, either expressed or implied, with respect to the contents hereof and specifically disclaims any warranties, merchantability or fitness for any particular purpose. Furthermore, the company reserves the right to revise this publication and to make changes from time to time in the contents hereof without obligation of the company to notify any person of such revision or changes.

Table of Contents

Introduction	1
Safety Instructions	1
FCC Statement	2
EEC STATEMENT	2
Shipping Contents	3
Optional Accessories	3
Projector Description	4
Projector	4
External Control Panel	5
Adjuster	6
Projector Features	6
Remote Control Description	7
Installing or Replacing Batteries	9
Installation	10
Display Size	10
Connecting to Various Equipment	11
Operation	12
Start Up	12
Digital Keystone Correction	13
Auto Adjustment	13
Source Selection	14
Menu System	14
1. VIDEO Menu	15
2. POSITION Menu	16
3. SPECIAL Menu	17
4. TRACKING Menu	18
Shutdown	19
Maintenance	20
Lamp Information	20
Use and Replacement of the Lamp	20
Lamp Replacement	20
Operative Information	21
Troubleshooting	22
Common Problems & Solutions	22
Status Messages	22



Specifications23
 Projector Specifications 23
 Timing Chart 24

Dimensions25

INTRODUCTION



Caution

TO PREVENT SHOCK, DO NOT OPEN THE CABINET. NO USER –SERVICEABLE PARTS INSIDE. REFER SERVICING TO QUALIFIED SERVICE PERSONNEL. PLEASE READ THIS USER’S GUIDE BEFORE YOU OPERATE YOUR PROJECTOR. SAVE THIS USER’S GUIDE FOR FUTURE REFERENCE .

Safety Instructions

1. Read this user’s guide before you operate your projector and save it for future reference.
2. The lamp becomes extremely hot during operation. Allow the projector to cool for approximately 45 minutes prior to removing the lamp assembly for replacement. Do not operate lamps beyond the rated lamp life. Excessive operation of lamps beyond the rated life could cause them to explode on rare occasions.
3. Never replace the lamp assembly or any electronic components unless the projector is unplugged.
4. To reduce the risk of electric shock, do not disassemble this appliance. Take it to a qualified technician when service or repair is required. Incorrect reassembly can cause electric shock when the appliance is subsequently used.
5. Do not place this product on an unstable cart, stand, or table. The product may fall, sustaining serious damage.
6. Do not touch the top cover when the projector is under operation.
7. The projector must be packaged into a carry bag while moving to another place for operation.

Caution

- Always open the lens shutter when the projector lamp is on.
 - Do not look straight at the projector lens during operation. The intense light beam may damage your eyes.
 - In some countries, the line voltage is NOT stable. This projector is designed to operate safely within a bandwidth of 100 to 240 volts, but could fail if power cuts or surges of ± 10 volts occur. In these high-risk areas, it is recommended that a power stabilizer unit be used in conjunction with this projector.
 - Do not place this projector on the top of cloth or carpet.
 - Do not touch the ventilation grill when the projector is under operation.
-

Save this user's guide: The information contained in this manual will assist you in operating and maintaining your personal projector.

FCC Statement

CLASS B: This equipment generates, uses and can radiate radio frequency energy and, if not installed and used in accordance with the instructions, may cause harmful interference to radio communications. However, there is no guarantee that interference will not occur in a particular installation. If this equipment does cause harmful interference to radio or television reception, which can be determined by turning the equipment off and on, the user is encouraged to try to correct the interference by one or more of the following measures:

- Reorient or relocate the receiving antenna.
- Increase the distance between the equipment and receiver.
- Connect the equipment into an outlet on a circuit different from that to which the receiver is connected.
- Consult the dealer or an experienced radio/TV technician for help.

EEC STATEMENT

This machine was tested against the 89/336/EEC (European Economic Community) for EMC (Electro Magnetic Compatibility) and fulfills these requirements.

Shipping Contents

The Projector is shipped with the cables required for connection to standard PC or laptop computers. Carefully unpack and verify that you have all the items shown below. If any of these items are missing, please contact personnel at the place of purchase.

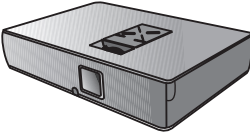

Projector



User's Guide



Quick Start Guide



Remote Control



3-2 Converter



Batteries

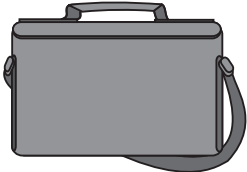

Deluxe Soft Carry Case

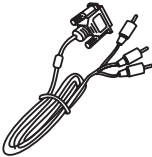

HDTV Cable (YPbPr)

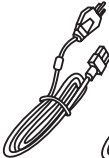

S.A. & India

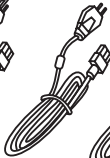

220V

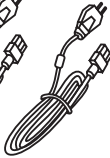

240V

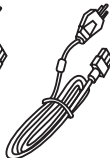

110V

Power Cord

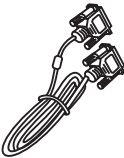

VGA Cable

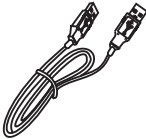

USB Cable

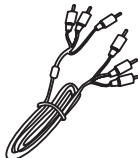

Video Cable

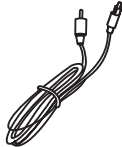

S-Video Cable

Optional Accessories

- 1. 150W lamp module
- 2. Macintosh adapter

Projector Description

Projector

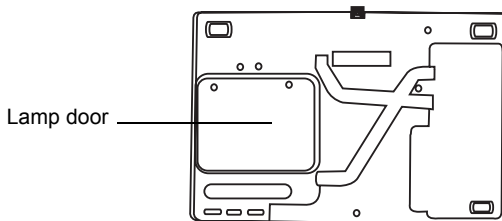
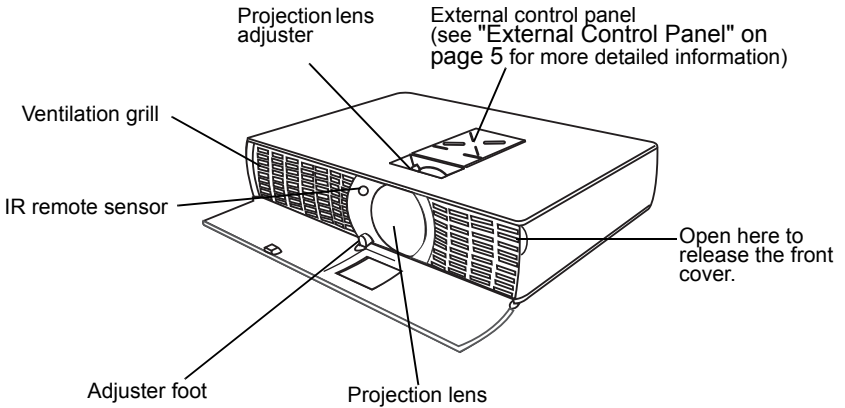
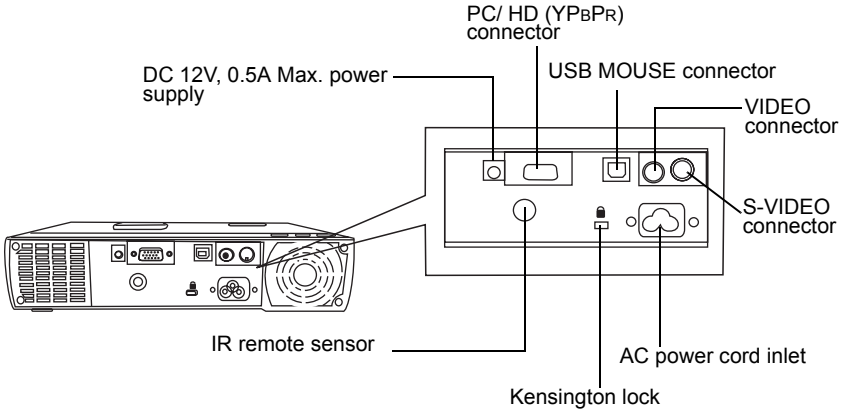

External Control Panel

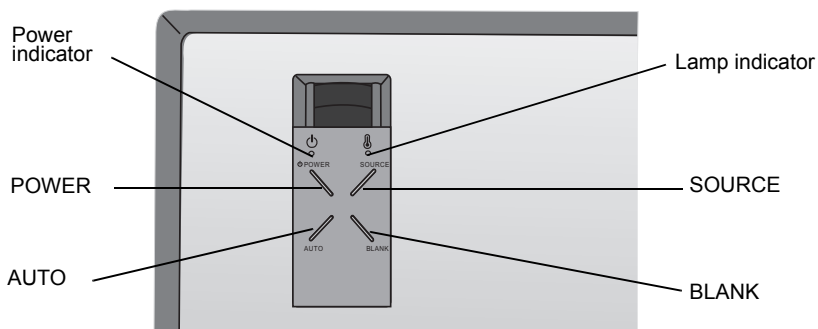

Power indicator

The indicator shows green for a normal state. When the projector is operated improperly, it shows green or orange toggle. See "Operative Information" on page 21 for more detailed information.

POWER

Press the **POWER** key to turn the projector on or off.

AUTO

Automatically determines the best picture settings for current received signals. (PC Mode Only)

Lamp Indicator

The Lamp Indicator will light up when the lamp needs service, cooling or replacement. See "Lamp Information" on page 20 for more detailed information.

SOURCE

Selects signal sources from among PC, Video, S-Video and YPBPR.

BLANK

Selects to display an entirely blue, black, green or LG logo screen.

Adjuster

The projector is equipped with 1 quick-release adjuster foot. Push the button to adjust its tilt angle.

1. Lift the projector up and press the adjuster button to release the adjuster.
2. The adjuster will drop into position and be locked.

Note: The adjuster can only bear the weight of the projector itself . Please do not place any additional weight burden on it.

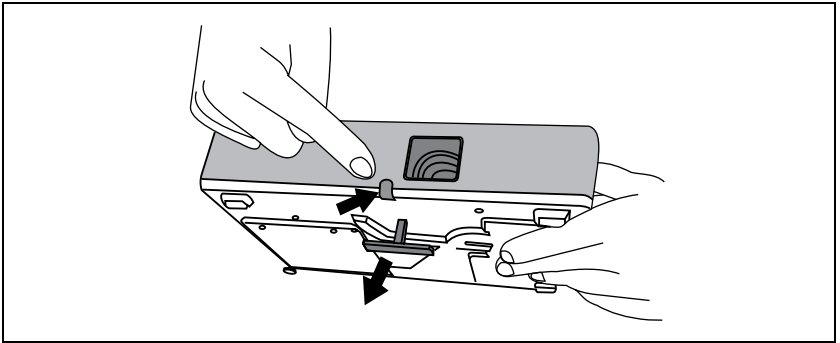

Projector Features

The projector integrates high-performance optical engine projection and a user-friendly design to deliver high reliability and ease of use.

The projector offers the following features:

- Small and light for portability.
- Full-function remote control with laser pointer/ remote mouse function.
- High quality manual zoom lens.
- One-key auto-adjustment to display the best picture quality in PC mode.
- Easy digital keystone correction through hot keys to correct distorted images.
- High resolution.
- Ultra-high brightness projection lamp.
- Ability to display 16.7 million colors.
- On-screen menus in 8 languages: English, French, German, Italian, Spanish, Korean, Simplified Chinese, and Traditional Chinese.
- Powerful AV function to provide high quality AV picture.
- HDTV compatibility (YPbPr).
- Durable magnesium alloy body.

Note: The brightness of the projected image will vary depending on the ambient lighting conditions and contrast/brightness settings.

Remote Control Description

The remote control sensors are located in the front/ back of the projector.

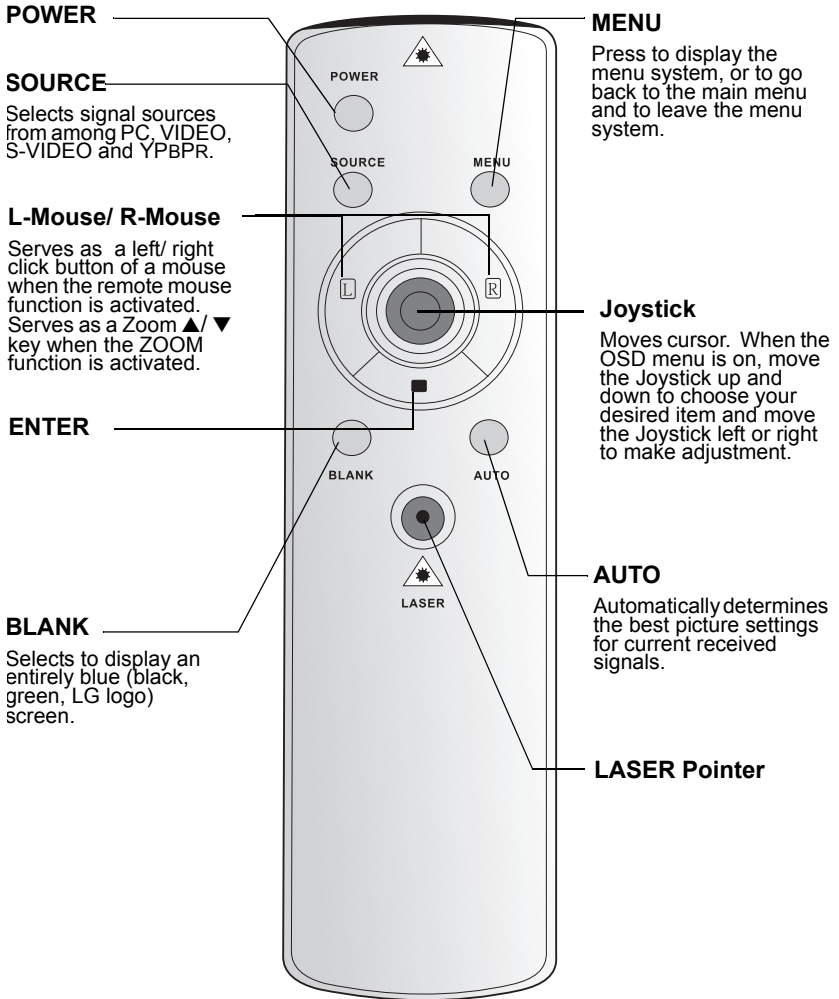

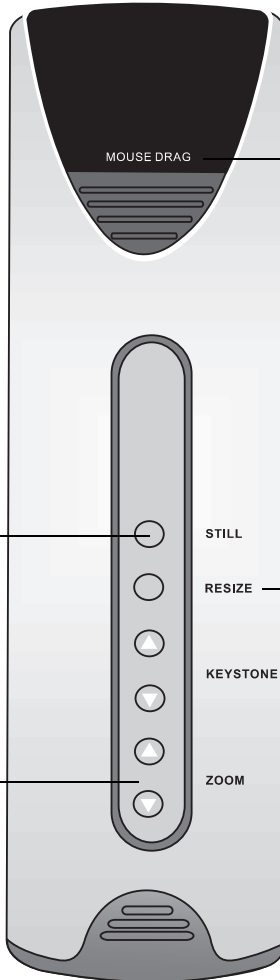

MOUSE DRAG

When the remote control works as a mouse, choose your desired item and press **MOUSE DRAG**. Drag it to wherever you want on the projection image and press **MOUSE LEFT** to release the item.

STILL

Makes the projection image still.

STILL

RESIZE

Scales the original input resolution.

RESIZE

KEYSTONE ▲ ▼

Refer to "Digital Keystone Correction" on page 13.

KEYSTONE

ZOOM

By pressing "ZOOM" button, zoom rectangular displays in the center, but to activate it, customer should press "ENTER" button and then it can be adjusted by Joystick.

ZOOM

Installing or Replacing Batteries (“AA” type)

❶ Press and open the battery compartment lid in the direction.

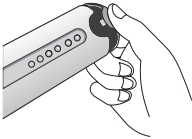

❷ Install batteries as indicated by the diagram inside the compartment.

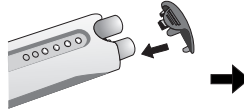

❸ Position the lid over the compartment and snap it back into place.



Caution

Avoid excessive heat and humidity. There may be danger of an explosion if batteries are incorrectly replaced. Replace only with the same or equivalent type recommended by the manufacturer. Dispose of used batteries according to the manufacturer’s instructions.

INSTALLATION

Display Size

Place the projector at the required distance from the screen according to the desired picture size (see the table below). The effective display size is from 26 to 178 inches diagonally for RD-JT31 and from 33 to 228 inches diagonally for RD-JT30.

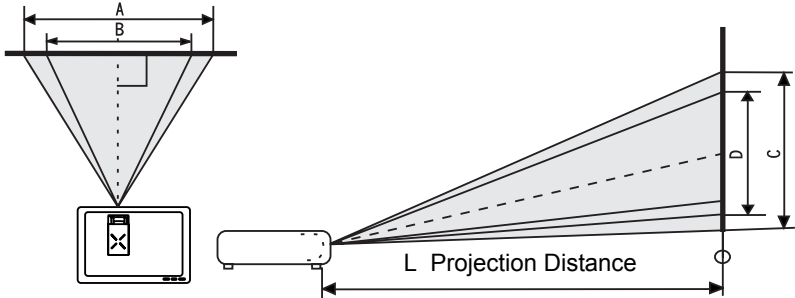

- RD-JT31 display size chart

Display Size (Max.)			L. Projection Distance (cm)	Display Size (Min.)		
Diagonal (in)	A. Width (cm)	C. Height (cm)		Diagonal (in)	B. Width (cm)	D. Height (cm)
33.4	67.9	50.9	150	25.7	52.2	39.2
44.5	90.5	67.9	200	34.3	69.6	52.2
66.8	135.7	101.8	300	51.4	104.4	78.3
89.1	181.0	135.7	400	68.5	139.2	104.4
111.3	226.2	169.7	500	85.6	174.0	130.5
133.6	271.5	203.6	600	102.8	208.8	156.6
155.9	316.7	237.5	700	119.9	243.6	182.7
178.1	362.0	271.5	800	137.0	278.4	208.8

- RD-JT30 display size chart

Display Size (Max.)			L. Projection Distance (cm)	Display Size (Min.)		
Diagonal (in)	A. Width (cm)	C. Height (cm)		Diagonal (in)	B. Width (cm)	D. Height (cm)
42.8	86.9	65.2	150	32.9	66.8	50.1
57.0	115.8	86.9	200	43.8	89.1	66.8
85.5	173.7	130.3	300	65.8	133.6	100.2
114.0	231.6	173.7	400	87.7	178.2	133.6
142.5	289.6	217.2	500	109.6	222.7	167.1
171.0	347.5	260.6	600	131.5	267.3	200.5
199.5	405.4	304.0	700	153.5	311.8	233.9
228.0	463.3	347.5	800	175.4	356.4	267.3

Connecting to Various Equipment

HDTV description

The projector is capable of displaying various High Definition TV display modes. Some of these sources are:

- Digital-VHS (D-VHS) player
- DVD player
- Satellite Dish HDTV receiver
- DTN tuners

Most of these sources will provide an analog component video output, a standard VGA output, or a YPbPr (default) format.

The projector is capable of accepting HDTV data through a YPbPr connector. Use a HDTV cable that came with your projector to display HDTV images.

The following standards are supported in the HDTV function:

- 480i
- 480p
- 720p
- 1080i

Please refer to "Menu System" on page 14 for information on the HDTV (YPbPr) OSD selections.

Connecting to Various Equipment

It only takes a few seconds to connect your projector to your desktop or notebook computer, VCR, or other systems. However, a Mac adapter (an optional accessory) is needed for connection to Macintosh computers.

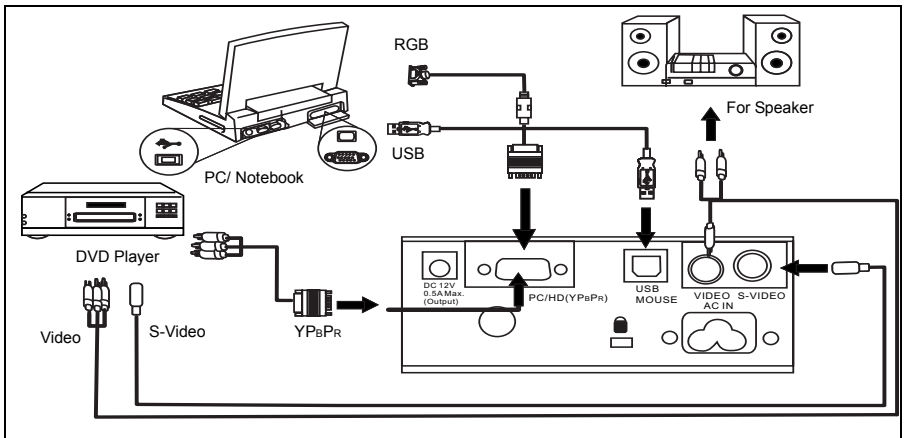

OPERATION

Start Up

1. Plug the power cord into a wall socket. Open the front Door to Power ON.

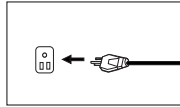

(110V)

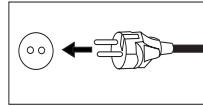

(220V)

2. When plugging-in, the ORANGE Leds light. Press the Power button to turn on the projector. Then, the fan will start to operate while the ORANGE Led is blinking. After 15 seconds, LG logo will display and pictures will be on after the next 15 seconds. (Green Led on)

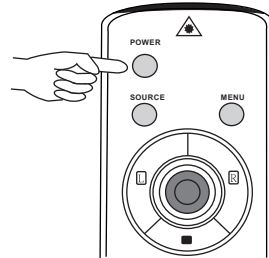
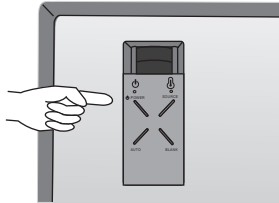

3. Switch on all connected equipment.

Digital Keystone Correction

Keystoning refers to the situation where the projected image is noticeably wider at either the top or bottom. To correct this, press KEYSTONE ▲/ ▼ (hot key) on the remote control, and then adjust the sliding bar labeled Keystone, as needed. Press ▲ to correct keystoning at the top of the image. Press ▼ to correct keystoning at the bottom of the image.

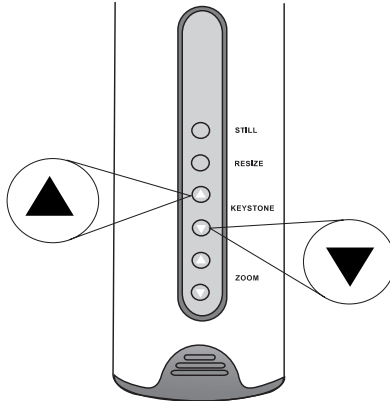

Auto Adjustment

In some cases, you may need to optimize the picture quality. To do this, press the AUTO key on the control panel of the projector or on the remote control. The built-in Intelligent Auto Adjustment function will re-adjust settings to provide the best picture quality.

**This function is available only in PC mode.*

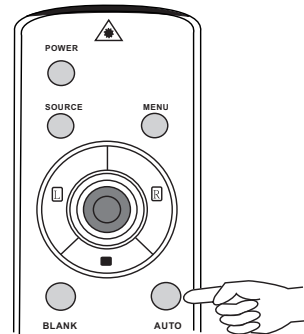
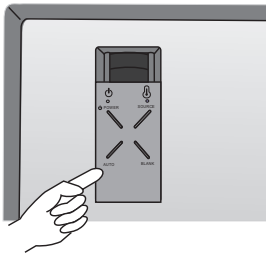

Source Selection

When several input sources are available, press the SOURCE key to make a selection from the control panel of the projector or the remote control.

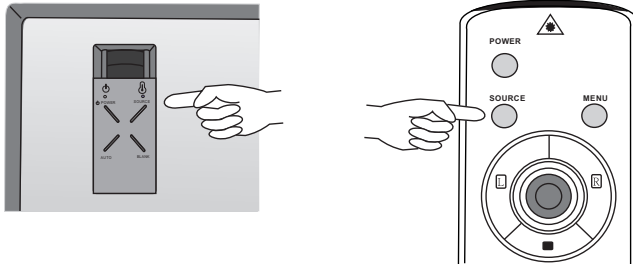

Menu System

Press **Menu** for the main menu, and then press Joystick to select a sub-menu.
Press **ENTER** again to select items in the sub-menu.

	Main Menu	VIDEO	POSITION	SPECIAL	TRACKING
Sub-Menu	YPbPr Video S-Video	Contrast Brightness Color Tint Reset	Keystone Zoom Resize	Language Flip Horizontal Flip Vertical Blank Image Lamp Time	
	PC (RGB)	Contrast Brightness Color R Color G Color B Reset	Horizontal Vertical Keystone Zoom Resize	Language Flip Horizontal Flip Vertical Blank Image Lamp Time	Auto Tracking Clock Phase

1. VIDEO Menu

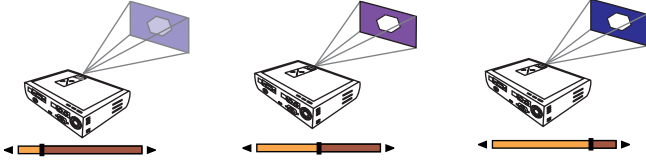
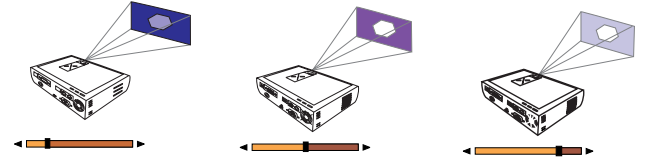
FUNCTION	DESCRIPTION
<p>Contrast</p>	<p>Adjusts the degree of difference between dark and light in the image.</p> 
<p>Brightness</p>	<p>Adjusts the brightness of the image.</p> 
<p>Color</p>	<p>Increases or decreases the color range of the image. <i>*This function is not available when the input mode is PC.</i></p>
<p>Tint</p>	<p>Adjusts the image to make it appear more red or green. <i>*This function is not available when the input mode is PC or PAL signal.</i></p>
<p>Color R Color G Color B</p>	<p>Increases or decreases the color temperature (R, G, B) of the image. <i>*This function is only available when the input mode is PC.</i></p>
<p>Reset</p>	<p>Returns all settings to the factory preset values.</p>

2. POSITION Menu

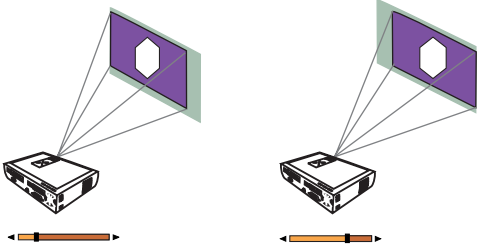
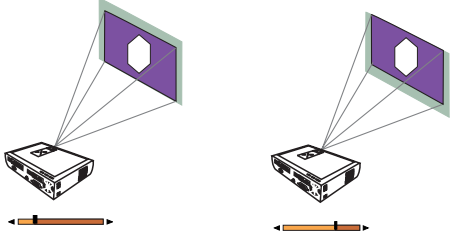
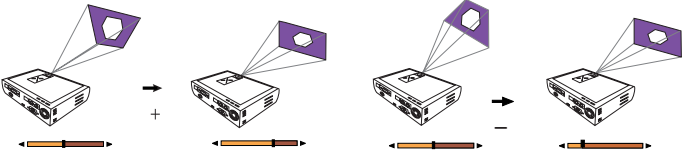
FUNCTION	DESCRIPTION
<p>Horizontal</p>	<p>Adjusts the horizontal position of the projected image.</p> 
<p>Vertical</p>	<p>Adjusts the vertical position of the projected image.</p> 
<p>Keystone</p>	<p>Corrects any keystone of the image.</p> 
<p>Zoom</p>	<p>Activates Zoom function.</p>
<p>Resize</p>	<p>When in YPbPr, Video and S-Video modes, users have two options for the image ratio: 4:3 and 16:9. When in PC mode, users have two options for the image ratio: Scaled and Original. JT30(XGA) operates in SVGA and VGA modes and JT31(SVGA) operates only in VGA mode.</p>

3. SPECIAL Menu

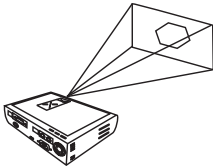
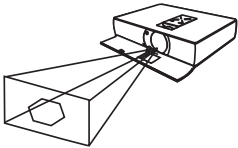
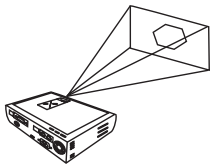
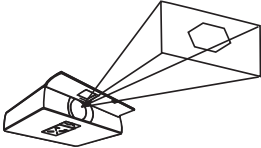
FUNCTION	DESCRIPTION	
Source	It's the same function with the SOURCE button on the remote control.	
Language	Language sets the language for the OSD control menus. Use the Joystick to select the desired language from among English, French, German, Italian, Spanish, Korean, Simplified Chinese and Traditional Chinese.	
Flip Horizontal	Default 	Projects images when the projector is 180 degrees horizontally rotated. 
Flip Vertical	Default 	Projects images when the projector is 180 degrees vertically rotated. 
Blank Image	Chooses blank image from among blue, black, green and LG logo.	
Lamp Time	Shows lamp usage time.	

4. TRACKING Menu

This sub-menu only works in PC mode.

FUNCTION	DESCRIPTION
Auto Tracking	It's the same function with the AUTO button on the remote control.
Clock	Adjusts to fit in the desired image size.
Phase	Adjusts to avoid the occurrence of flicker. 

Shutdown

1. Press **POWER** and a warning message will appear. To turn off the projector, press **POWER** again.

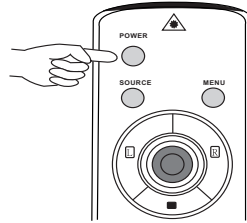
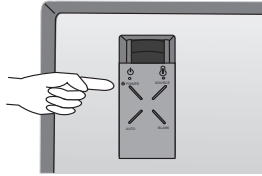

Are You Sure To Power Off?

Press "Power" Again To Power Off.

2. To cool down the projector, the fan will continue to run for approximately 90 seconds, during which the LED will flash.

* After the projector is turned off, there is a 90-second cooling period before the projector can be re-started.

3. Disconnect the power cord from the wall socket.

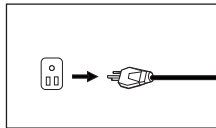

(110V)

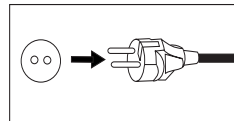

(220V)

Caution

- Please do not unplug the power cord before **POWER** is shut down or during the two-minute cooling process.
 - If the projector is not properly shut down, to protect the lamp, the system will detect this and cool the lamp for 90 seconds automatically before turning on again.
-

MAINTENANCE

Lamp Information

Use and Replacement of the Lamp

The lamp life is 1500 hours. When the Power Indicator lights up red and the Lamp Indicator lights up orange or a message appears suggesting the time of lamp replacement, please install a new lamp or consult your dealer. An old lamp could cause a malfunction in the projector and in rare instances may even explode.

Lamp Replacement

Please check with LG service center for the information of lamp replacement.

Caution

HIGH VOLTAGE/ HIGH TEMPERATURE/ HIGH PRESS

WHEN REPLACING THE LAMP, TURN OFF THE PROJECTOR AND PULL OUT THE CORD FROM THE RECEPTACLE BEFORE REPLACING THE LAMP.

WAIT UNTIL THE LAMP BECOMES COOL (MINIMUM 45 MINUTES).

TOUCHING THE LAMP WHEN IT IS HOT MAY CAUSE A BURN ON YOUR HAND.

HIGH-PRESSURE LAMP WHEN HOT MAY EXPLODE IF IMPROPERLY HANDLED.

To reduce the risk of injuries to fingers and damage to internal components, use caution when removing lamp glass that has shattered into sharp pieces.

To reduce the risk of injuries to fingers and/or compromising image quality by touching the lens, do not touch the empty lamp compartment when the lamp is removed.

This lamp contains mercury. Consult your local hazardous waste regulations to dispose of this lamp in a proper manner.

Operative Information

When the two LED light up, they are warning you of the following possible problems:

State	LEDs Display		Description
	Operation LED	Status LED	
Normal	Green	No color	Projector runs as Normal State. Lamp Time < 1400 hours Temperature < 72°C
Lamp On Error	Orange	Orange	Check whether the Lamp is lit or not.
Lamp Time over Error	Orange	Orange Toggle	1400 hours < Lamp Time < 1500 hours
	Red	Orange	Lamp Time > 1500 hours Please change the lamp to keep good performance.
Temperature error	Orange	Red Toggle	72°C < Temperature <74°C
	Red	Red	Temperature > 74°C The lamp temperature is very high! Please turn off the projector.
Front cover closed	Green	Red	Check whether the Front cover is closed.
Fan On Error	Orange Toggle	Red	Check whether Fan is operated normally or not.
Lamp Case Open	Green	Orange	Check whether Lamp case is open.

TROUBLESHOOTING

Common Problems & Solutions

PROBLEMS	TRY THESE SOLUTIONS
NO POWER	<ul style="list-style-type: none"> • Make sure the power cord is inserted snugly into the AC adapter socket. • Make sure the power cord is inserted snugly into the power outlet. • Wait 90 seconds after the projector is turned off before turning the projector back on. • Check whether Front Cover is closed.
NO PICTURE	<ul style="list-style-type: none"> • Check for the proper input source. • Ensure all cables are connected properly. • Adjust the brightness and contrast.
TRAPEZOID IMAGE ON THE SCREEN	<ul style="list-style-type: none"> • Reposition the unit to improve its angle on the screen. • Use the Keystone correction key on the remote control unit.
POOR COLOR	<ul style="list-style-type: none"> • Select the correct video system. • Adjust brightness, contrast, or saturation.
BLURRED IMAGE	<ul style="list-style-type: none"> • Press Auto on the control panel of the projector or the remote control unit to get better picture quality. • Adjust the focus. • Reposition the unit to improve its projection angle. • Ensure the distance between the unit and screen is within the adjustment range of the lens.
REMOTE CONTROL DOES NOT WORK	<ul style="list-style-type: none"> • Replace the batteries with new ones. • Make sure there is no obstacle between the remote control and the projector. • Make sure nothing is blocking the front and rear receivers.

Status Messages

On-Screen Messages	Description
No Signal	Projector is searching for input.
Out of Range	Input signal frequency exceeds the projector's range.
Replace the Lamp	The lamp has been in operation for over 1500 hours. The warning message will display on screen. Replace the lamp when the warning message displays or the projector may not be turned on.

SPECIFICATIONS

Projector Specifications

Technical Specifications

Note: All specifications are subject to change without notice.

General

Product name	Personal Projector
Model name	RD-JT30 1024X768 XGA RD-JT31 800X600 SVGA

Optical

Display system	1-CHIP DMD
Lens F/Number	F/2.4
Lamp	150W NSH lamp

Electrical

Power supply	AC100 ~ 240V, 3A, 50/60 Hz (Automatic)
Power consumption	250 W (Max)

Mechanical

Dimensions	248 mm (W) x 59 mm (H) x 170 mm (D)
Operating temperature range	5°C ~ 35°C
Weight	3 lbs (1.7 Kg)

Input terminal

Computer input	
RGB input (HDTV: YPBPR)	D-sub 15-pin (female)
Video signal input	
S-VIDEO	Mini DIN 4-pin port x1
VIDEO	RCA jack x1

Output

USB mouse connector	A/B series x1
---------------------	---------------

Timing Chart

Resolution	H Sync (kHz)	V Sync (Hz)	Remark
640x350	31.5	70.1	
640x400	37.9	85.1	VESA
720x400	31.5	70.0	
720x400	37.9	85.1	VESA
640x480	31.5	60.0	VESA
640x480	35.0	66.7	Macintosh
640x480	37.9	72.8	VESA
640x480	43.3	85.0	VESA
800x600	35.2	56.3	VESA
800x600	37.9	60.3	VESA
800x600	48.1	72.2	VESA
800x600	46.9	75.0	VESA
800x600	53.7	85.1	VESA
832x624	49.7	74.5	Macintosh
1024x768	48.4	60.0	VESA
1024x768	56.5	70.1	VESA
1024x768	60.0	75.0	VESA
1024x768	68.7	85.0	VESA
1280x1024	64.0	60.0	VESA

DIMENSIONS

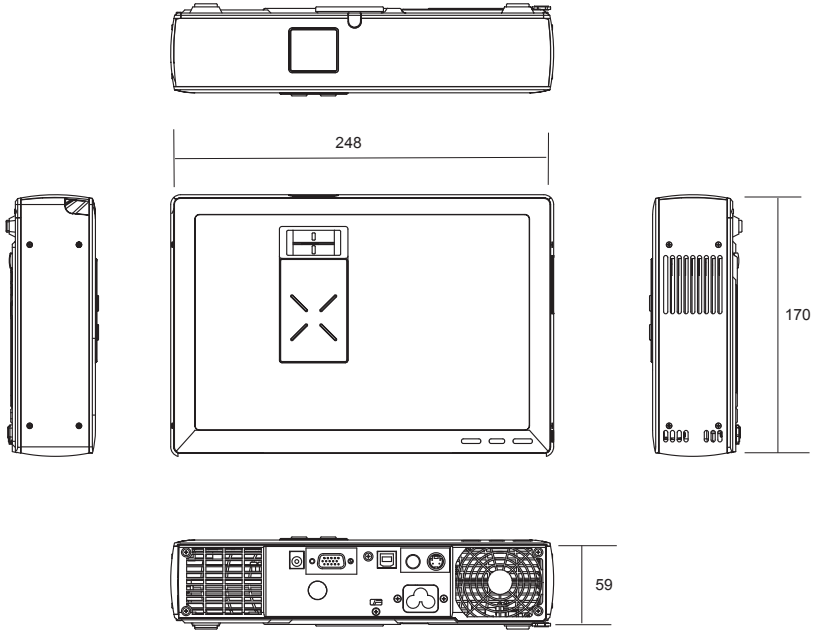

Unit: mm